

Convection on a non-uniformly heated, rotating plane

By **E. L. KOSCHMIEDER**

Department of the Geophysical Sciences
The University of Chicago, Chicago, Illinois 60637

(Received 3 November 1967)

This investigation is concerned with the convective motions in a shallow layer of silicone oil on a plane, circular copper plate which is heated at the rim and cooled at the centre and at the same time rotated around a vertical axis. The oil is in touch with a glass lid, which is cooled uniformly. With sufficient heating axially symmetric concentric rings develop. The details of the motion can be described as a superposition of a circulation due to the horizontal temperature gradient and a circulation of opposite sense due to the centrifugal force, with the motions due to the vertical instability. There seems to be a conversion into rolls whose axes point radially, if the centrifugal circulation becomes too strong.

1. Introduction

It is of some geophysical interest to study the convective motions on a non-uniformly heated rotating plane. To prepare an experimental investigation of this problem Koschmieder (1966) showed that for moderate supercritical Rayleigh numbers the motions on a resting, non-uniformly heated plane are a superposition of a circulation due to the horizontal temperature gradient upon the motions due to the vertical instability. This result has been confirmed theoretically by Müller (1966). The circulation due to the horizontal temperature gradient will henceforth be called density circulation. In the subsequently described experiments the density circulation is ascending at the rim, as the warmest part of the bottom plate. The fluid then moves along the lid to converge and descend at the centre and returns along the bottom. Later the convective motions on a uniformly heated rotating plane were examined for moderate Rayleigh and Taylor numbers by Koschmieder (1967). In this case the motions are mainly a superposition of a centrifugal circulation upon the motions due to the vertical instability. The centrifugal circulation is due to the vertical density difference of the unstably stratified fluid. As in a centrifuge the heavy cool fluid on top is forced to the rim, while the warm light fluid at the bottom moves inwards. Consequently it was expected that the convective motions on a non-uniformly heated rotating plane would be a superposition of a density circulation, a centrifugal circulation and the motions due to the vertical instability, for moderate Rayleigh numbers and moderate rotation rates. The results below confirm this qualitative prediction.

2. Description of the apparatus

The apparatus, as shown in figure 1, is an improved version of the apparatus used earlier by Koschmieder (1966). The copper bottom plate of 12 mm thickness and 250 mm diameter overlaps at its outer edge a 25 mm wide and 50 mm deep water tank, which can be heated by a resistance wire at the bottom. The inner

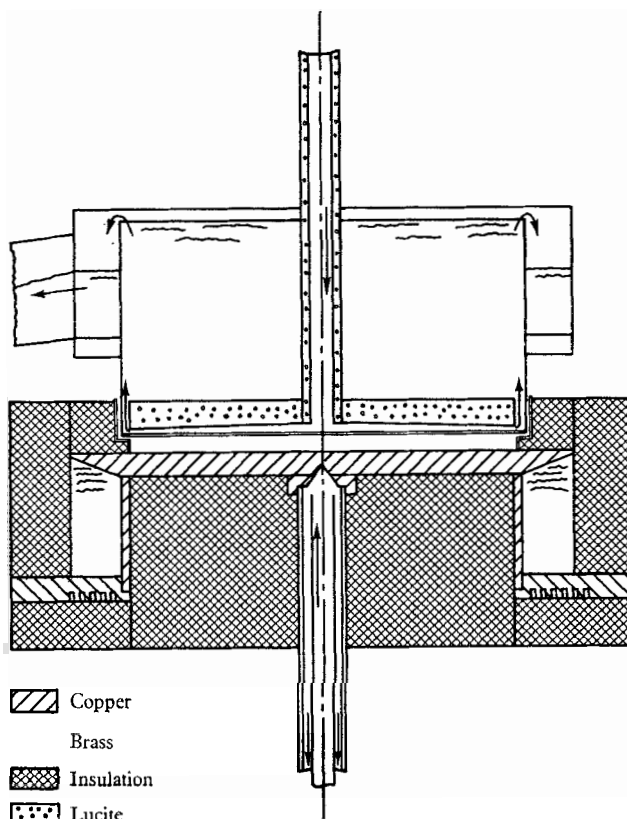

FIGURE 1. Section of the apparatus.

wall of the water tank was of 3 mm thick copper, soldered to the copper bottom plate. The centre of the copper plate can be cooled, in the way shown, by a water jet which was fed into the system through a rotary gland. The long narrow centre pipe introduced sufficient resistance to limit the circulation to $70 \text{ cm}^3/\text{sec}$. Thermal insulation between the centre cooling and the inner wall of the circular water tank is provided by a press fit styrofoam disk. If the centre and rim of the copper plate are at different temperatures, the heat flux through the plate produces a radial temperature distribution. The temperature should approximately be proportional to the logarithm of the radius. For a graph of three such temperature distributions see figure 18. The temperature distribution is measured by a row of five copper-constantan thermocouples attached to the bottom of the plate. At 180° from the five thermocouples another set of three couples was

placed to check azimuthal temperature differences. Great care was taken to achieve uniform temperatures at the rim of the fluid layer, since that had proven to be troublesome previously. The wall containing the oil laterally was a 1 mm thick Bakelite ring of 200 mm inner diameter from which, 8 mm above the copper, a shoulder extended horizontally outward. The lid rested on three 0.25 mm thick spacers attached to the shoulder. The depth of the fluid layer was therefore 8.25 mm. The Bakelite ring was cemented to the copper plate in a 1 mm deep groove, and was surrounded by a press fit styrofoam ring. The 2 mm thick bottom glass plate of the lid was cooled as shown in figure 1 by around 150 cm³/sec of water circulated from a controlled water-bath. The outside of the apparatus was wrapped with a 50 mm thick layer of foam rubber for thermal insulation. The apparatus could be levelled and was mounted on a turntable with a continuously variable drive. The rotation rate did not vary more than 10⁻³. The silicone oil used was Dow Corning 200 fluid of a 1 stokes viscosity. For a list of the other properties of the oil, see Koschmieder (1966). Motions of the oil were made visible with aluminium powder as previously. Pictures were taken with the lucite water distributor on top of the glass plate removed. To simplify photography, the copper plate was blackened chemically.

3. Experiments without rotation

The apparatus was first checked for its quality by a reproduction of the results obtained earlier without rotation. The simplest test is to heat up the copper plate from the rim, without cooling the plate centre. This procedure will be called quasi-uniform heating. There remains a minimal non-uniformity of the plate temperature, due to the vertical heat flux through the oil layer. Heat conducted upwards through the oil is supplied through the copper plate, which implies a radial temperature gradient in the plate. The quasi-uniform heating permits an experimental determination of the critical vertical temperature difference ΔT_c . Starting with a stable vertical temperature difference, the bottom temperature was raised slowly, till at 108 μV ($1\mu\text{V} = 2.5 \times 10^{-2} \text{ }^\circ\text{C}$) a roll parallel to the rim had formed. There were two rings at $\Delta T = 150 \mu\text{V}$, six at 166 μV , eight at 170 μV and 12 perfect concentric rolls at 174 μV , 2 h after the rim roll had formed. The critical temperature difference ΔT_c , determined when the motions covered the plate completely, was therefore $\Delta T_c = 3.78 \text{ }^\circ\text{C} \pm 5\%$, while the theoretical ΔT_c , which follows from $R_c = 1707$, is $\Delta T_c = 3.68 \text{ }^\circ\text{C}$. All eight thermocouples at the bottom thus far showed no differences larger than $\pm 0.5 \mu\text{V}$. This is the accuracy of the measurement, mainly given by the inaccuracy of a multiple switch, used for all thermocouples. The temperature differences given for the appearance of the different number of rings are only of qualitative nature, since there is no criterion for the proper establishment of a particular ring. Increased heating now reduced the number of the rings as was found previously, till at $\Delta T = 775 \mu\text{V}$ only nine rings were left. The horizontal temperature difference had now increased to 15 μV . After the tenth ring was gone a disturbance appeared in the rim roll and the experiment was discontinued.

With non-uniform heating, a pattern of concentric rings was easily established.

It will be necessary to describe these motions in detail. A schematic sketch of a sequence of such motions with slowly increased heating is shown in figure 2. The procedure was as follows. The temperature of the cooling water for the lid and the plate centre were set at constant but different values, the lid being always

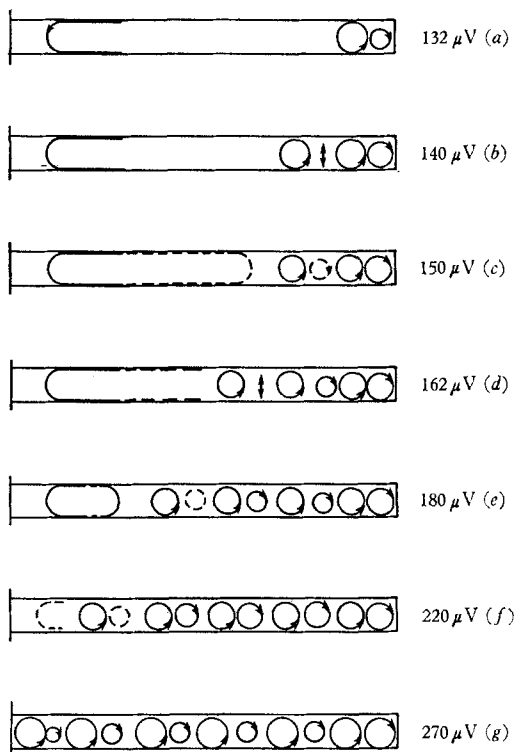

FIGURE 2. Sequence of motions without rotation.

warmer than the bottom centre. The difference of these values will be called the nominal temperature difference ΔT_n , which is constant in each experiment. The radial temperature difference ΔT_r is the difference of the temperatures of the cooling water for the copper plate centre and the water in the tank at the rim. ΔT_r was varied slowly in each experiment by increased heating of the water tank. Due to the logarithmic temperature distribution in the copper plate only a fraction of ΔT_r really affects the fluid, since the logarithmic decrease of the temperature at the centre will not extend to the top of the copper plate. Thus ΔT_r merely indicates the effective radial temperature difference.

With 12°C nominal temperature difference and slowly increased ΔT_r , the first detectable motion, besides the density circulation, was a circular roll, separated from the rim by a circular area of no detectable motions. Later on, a faint roll at the rim developed, to produce the pattern shown in figure 2*a*. The corresponding temperature distribution in the bottom plate is listed in table 1. The temperature difference ΔT between bottom and top of the oil layer at the outermost thermocouple is listed with the figures. The reference thermocouple

for these measurements was in the water-bath for the lid cooling. The accuracy of the e.m.f.'s is approximately $\pm 1\%$. The position of the couples is inaccurate to about ± 1 mm due to the mounting. The later appearance of the rim roll

r [mm]					t (min)	Figure
90	70	50	30	20		
ΔT [μV]						
132	—	—	—	—	0	2 <i>a</i>
140	124	104	74	50	40	2 <i>b</i>
150	134	114	83	60	50	2 <i>c</i>
154	138	118	88	64	60	2 <i>d</i>
177	159	138	108	83	140	2 <i>e</i>
220	200	176	144	118	180	2 <i>f</i>
270	252	225	190	162	225	2 <i>g</i>
405	380	350	307	276	300	5
860	820	770	705	645	600	6

TABLE 1

as compared to the second roll from the rim, is probably due to descending motions right at the wall, caused by the heavy cool oil in the 0.25 mm deep gap between the Bakelite ring and the glass plate of the lid. These descending motions are countered by motions ascending at the wall as the warmest point of the bottom. The rim roll is therefore at first omitted and turns outwards on top. Nothing has been done to correct this, since the rim roll would turn outwards with rotation anyhow.

The figure 2*b* corresponds to the pattern at a slightly raised temperature 40 min later. There are two rings inwards from the rim followed by a shear layer, another ring further inwards and the density circulation. The motions are now exactly as they have been found previously, each second ring which turns against the density circulation is first omitted. Instead a shear layer forms between two rolls which turn the same way. The shear layer is later replaced by a thin counter roll, which turns against the density circulation (figures 2*c*, *d*). These events are typical for nonuniform heating and have been discussed in detail (Koschmieder 1966). A photograph of a counter roll (figure 3, plate 1), just as it appeared at a slightly higher temperature than at figure 2*d*, illustrates the situation. The bright rings in figure 3 are the rolls. The third ring from the rim, which is evidently smaller than the two rolls adjacent to it, is a counter roll. The dark circular ring inwards from the fourth roll is a shear layer. Since the aluminium particles align vertically in an area of no motion, the shear layers do not reflect light and therefore appear dark on the photographs. Inwards from the shear layers is another roll, followed by the density circulation. The centre of the oil layer appears dark again, since the motions descend there.

The appearance of concentric rolls and counter rolls continued (figure 2*e-g*), till 4 h after the first ring had appeared, 12 concentric rings covered the plate. A picture of the pattern is shown in figure 4, plate 1. Note the very thin innermost counter roll. The innermost ring was not really axial symmetric (repeatedly). This became more obvious, when the temperature was raised further. The

centre ring then split and disappeared irregularly, leaving 11 rings, which became symmetric again as is shown in figure 5, plate 1. The very bright lines between the pairs of rolls originate from aluminium powder settled at the bottom under the maxima of ascending motion. As the temperature increased, the eleventh and tenth ring disappeared, demonstrating an increase of the wavelength of the convective motions with increased Rayleigh number. This has not explicitly been stated for non-uniform heating previously. Figure 6, plate 2, finally shows what the motions looked like after the tenth ring was gone. The peculiar square wave pattern of the two outermost rings had started to develop very slowly in the rim roll from one particular point on, while there were still ten rings. It indicates that the fluid is now sensitive for azimuthal disturbances, but it does not necessarily mean that the fluid is now unstable against infinitesimal disturbances. Infinitesimal disturbances should produce the waves simultaneously around the circumference.

At a nominal temperature difference of 32°C , which was about the largest ΔT_n which could be obtained, almost the same sequence of events was observed when ΔT_n was increased again. The main difference was that the plane was now covered initially with 11 perfect rings, not 12 as mentioned above. This is most likely caused by the increase of the wavelength of the motions in the outside portions of the oil layer, where the vertical temperature difference is increasingly supercritical. In other words, the outermost rings have expanded so much that no place is left for a twelfth ring at the centre. With increased heating 10 perfect rings remained when the reading of the outermost thermocouple (ΔT_1) was $670\ \mu\text{V}$. The radial temperature difference across the bottom was therefore about 50°C . No further heating was possible. It is noteworthy that under these conditions, where the outermost vertical temperature difference was approximately 4 times ΔT_c , the motions still consisted of rolls and counter rolls. Thus the superposition of the motions due to the vertical instability with the density circulation still holds.

4. Experiments with rotation

The first rotation rate tried was $\frac{1}{4}$ revolution per second. The Taylor number N_T is in this case $N_T = 4.6$. A sequence of the motions which occurred, when the nominal temperature difference has 12°C is shown in figure 7. Table 2 lists the corresponding temperature distributions at the bottom. While the rotation rate was kept constant, heating started from a stable vertical temperature difference on. From around $\Delta T_1 = 60\ \mu\text{V}$, a roll adjacent to the rim could be observed, contrary to the events without rotation, when the rim roll was omitted at first. The early appearance of the rim roll is the first sign of the centrifugal circulation, note the small vertical temperature difference. Figure 7*a* shows the rim roll followed directly by a weak and rather wide second roll. This roll contracted and formed a narrow counter roll to the centrifugal circulation, figure 7*b*. The next figure shows both these rolls followed by a shear layer and another roll further inwards. The shear layer was then replaced by a counter roll to the density circulation (figure 7*d*). The immediate sequence of 2 counter rolls, each acting against a different circulation, was typical for the experiments with rotation. The

place, where the two consecutive counter rolls appear, indicates the location, where density and centrifugal circulation balance. Both circulations extend over the whole plate. The density circulation moves inwards on top and is

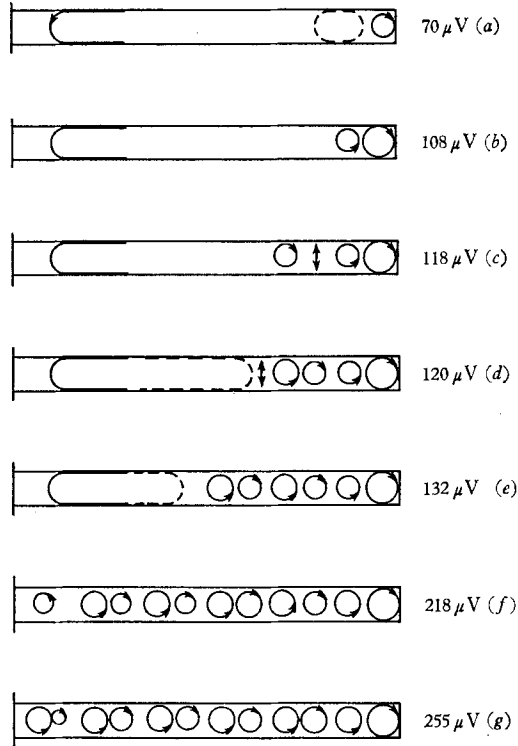

FIGURE 7. Sequence of motions with $\frac{1}{4}$ r/s.

r [mm]					t [min]	Figure
90	70	50	30	20		
ΔT [μV]						
70	—	—	—	—	0	7a
110	96	75	45	20	45	7b
120	102	82	51	27	53	7c
122	105	83	53	28	60	7d
130	114	91	60	36	90	7e
218	198	173	137	109	310	7f
255	235	207	169	139	355	7g
760	725	685	630	592	—	8

TABLE 2

intense at the centre, due to the increased temperature gradient and the convergence of the flow. The centrifugal circulation moves outwards on top. Due to the dependence of the centrifugal force on the radius, the centrifugal circulation is weak at the centre and intense at the rim. The location, where both

circulations balance varies according to the values of the angular velocity and the temperature gradient, as will be seen soon.

Inwards from the 2 rolls adjacent to the rim, the motions were now governed by the density circulation and followed exactly the developments described above (figures 7 *e-g*). The centre ring was again slightly unsymmetric and split at increased heating while the pattern with 11 rings was again of perfect symmetry. Heating further, the eleventh and tenth ring disappeared. In one of these experiments a number of small air bubbles had entered the chamber. With increased

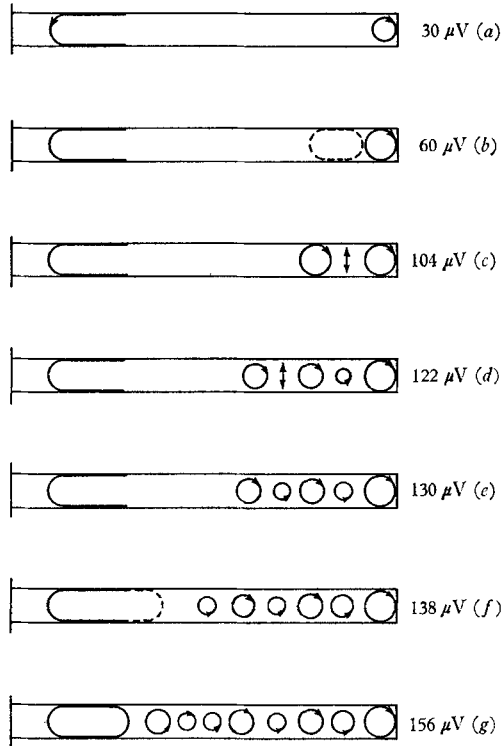

FIGURE 9. Sequence of motions with $\frac{1}{2}$ r/s.

heating they moved slowly (over a period of hours) towards the centre. It was surprising that they did not induce azimuthal waves in the rings. Instead the rings remained symmetric except, of course, along the path of the bubbles. Without air bubbles in the oil, the counter roll of the centrifugal circulation became wavy after the tenth ring was gone. Slowly heating further, this ring developed a square wave pattern as is shown in figure 8, plate 2. Note that the rim roll in this case is hardly affected, in contrast to figure 6. This shows once more the very different stability of rolls and counter rolls against azimuthal disturbances. The next truly wavy pattern appeared now in the fourth ring from the rim. Since the waves in the outermost counter roll slowly lost their symmetry, the experiment was then discontinued.

With the rotation rate increased to $\frac{1}{2}$ r/s ($N_T = 18$), the influence of the centrifugal force became much more obvious. For the development of the motions

see figure 9, for the corresponding temperature distributions, table 3. The rim roll appeared now at about $30 \mu V$ vertical temperature difference at the outermost thermocouple (figure 9*a*). It was then followed by a weak but rather wide roll, which only separated definitely from the rim roll after increased heating. At $\Delta T_1 = 100 \mu V$ (figure 9*c*) there were two distinct rolls, separated by a clear shear

r [min]					t (min)	Figure
90	70	50	30	20		
ΔT [μV]						
34	20	3	- 22	- 41	0	9 <i>a</i>
64	50	31	5	- 15	30	9 <i>b</i>
102	86	66	39	16	75	9 <i>c</i>
124	108	88	58	36	100	9 <i>d</i>
130	114	93	64	41	110	9 <i>e</i>
134	119	97	68	44	120	9 <i>f</i>
150	134	114	83	59	135	9 <i>g</i>
240	222	198	162	135	190	13

TABLE 3

layer, which was later on replaced by the first counter roll (figure 9*d* and figure 10, plate 2). When the second counter roll had formed (figure 9*e*), there was inwards from the fifth ring a comparatively wide area with no visible motions which nearer to the centre gradually transformed into the density circulation (see figure 11, plate 3). In figure 11 the lucite water reflector on top of the glass plate was not removed. In the motionless area, where apparently centrifugal and density circulation balance each other, two counter rolls developed consecutively later on (figures of 9*f*-*g*). In particular the photograph figure 12, plate 3, shows that the seventh ring develops as a counter roll, while so far the counter rolls were even numbered rings. The motions were of perfect symmetry up to the appearance of the sixth ring. They began to lose their symmetry then, when the first counter roll developed azimuthal waves. These waves did not appear simultaneously along the whole circumference of the second ring, but developed from three different locations, in particular one point was troublesome.

The greatest effort in all of these experiments has been made to remedy this situation, with only marginal results. The temperature distribution at the bottom was found to be not exactly axially symmetric, the readings at the set of three thermocouples were persistently around 1% lower than at the set of five couples. Since variations of the water input at the plate centre as well as changes at the lid proved to be unsuccessful, it was finally assumed that the waves originated from an azimuthal non-uniformity of the bottom temperature produced by an imperfect solder joint at the centre of the copper plate. No other reason could be found, why the plate temperature along one sector apparently was always higher than the average. The counter rolls always developed in this area first and the disturbances likewise. It was not possible to remedy the questionable solder joint. It seems, furthermore, to be likely that even with an improved tempera-

ture distribution at the bottom, the waves would have appeared either at an increased temperature difference or at faster rotation.

Heating further produced more rings closer to the centre and increased the radial amplitudes of the waves. The ninth roll was a counter roll against the density circulation. When this ring established at $\Delta T_1 = 188 \mu\text{V}$, the fourth ring from the rim, which was originally the second counter roll against the centrifugal circulation, began to develop azimuthal waves too. The rim roll and the third ring thus far were hardly affected by the waves. Again at increased ΔT_1 , the centre ring appeared at $\Delta T_1 = 210 \mu\text{V}$, separated from the tenth ring by a shear

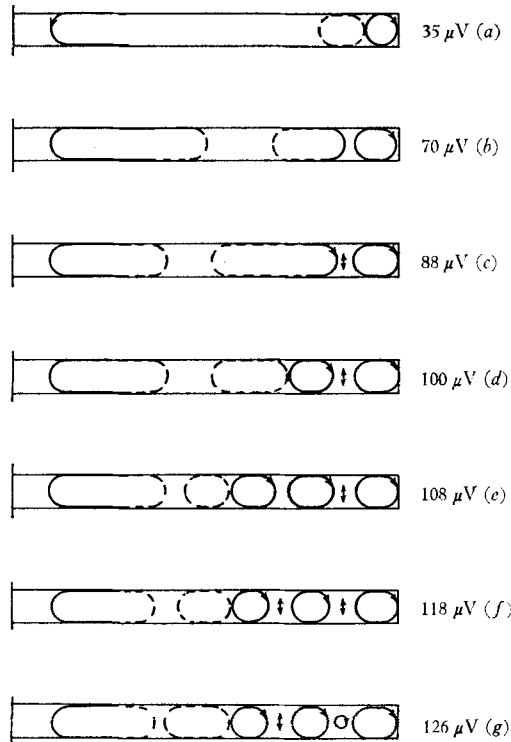

FIGURE 14. Sequence of motions with $\frac{3}{4}$ r/s.

layer. The waves in the second and fourth ring began to combine now, cutting the rim roll and the third ring. Neither of these rings ever developed a wavy structure. Finally, at $\Delta T_1 = 240 \mu\text{V}$, when the last counter roll (eleventh ring) had formed, the outermost six rings had transformed completely into rolls nearly perpendicular to the rim (see figure 13, plate 3).

At $\frac{3}{4}$ r/s ($N_T = 41$) the influence of the centrifugal forces became almost dominant. For the sequence of motions with increased ΔT_1 , see figure 14, the temperature distributions can be inferred from the values of ΔT_1 and table 3. The rim roll could already be observed at $\Delta T_1 = 20 \mu\text{V}$, soon to be followed by a faint second roll, figure 14*a*, which became very wide and did not immediately separate from the rim roll. A true transparent shear layer could be observed at

$\Delta T_1 = 88 \mu\text{V}$ (figure 14c), the second ring was then at least two times the width of a regular roll. Later on a third ring split off from the second, although both rings were again not really separated at first. The photograph figure 15, plate 4, and figure 14e now show four rings. The second, third and fourth ring show marked differences in the intensity of the circulation and are not definitely separated from each other yet. Inwards from the fourth ring is a distinct density circulation. Figure 16, plate 4 then shows the second shear layer and a combination of the third and fourth ring. A little later (figure 17, plate 4 and figure 14g) and

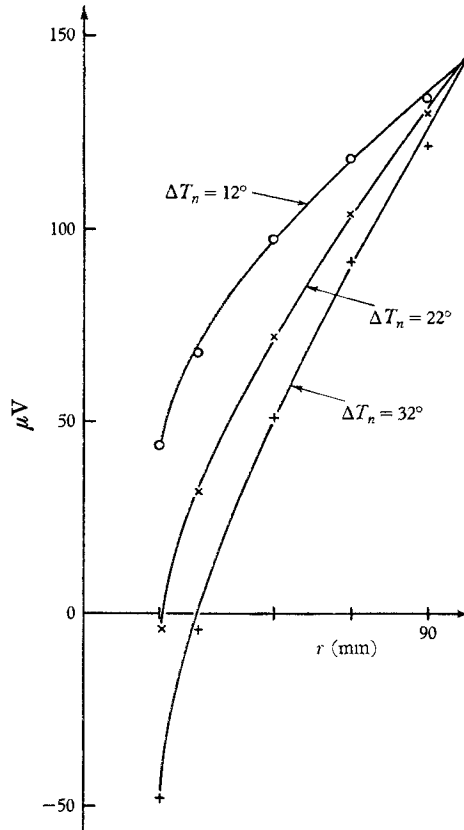

FIGURE 18. Temperature distribution in copper plate.

the first counter roll appeared in the outermost shear layer. This counter roll was of not more than 2 mm cross-section and formed immediately azimuthal waves. Although the waves again did not develop uniformly along the circumference of the counter roll, the rapid way in which they developed and intensified indicates that such a narrow counter roll is very sensitive against disturbances. This agrees well with the observations made previously by Koschmieder (1967). At $\Delta T_1 = 144 \mu\text{V}$ the waves in the first and second counter roll began to combine. There was then a clear shear layer between the third and fourth ring and another inwards from the fourth ring and finally the density circulation. The motions now lost their symmetry so quickly that the experiment was discontinued.

While in the experiments described above the nominal temperature difference was always 12°C , in another series the rotation rate was constant at $\frac{1}{2}$ r/s and ΔT_n increased to 22°C and 32°C . Due to an intensified density circulation the extent of the centrifugal circulation should then diminish. And in fact with $\Delta T_n = 22^\circ\text{C}$ and $\Delta T_1 = 124 \mu\text{V}$ the two consecutive counter rolls which indicate the location where density and centrifugal circulation balance, appeared as the fourth and fifth ring. With $\Delta T_n = 32^\circ\text{C}$ and $\Delta T_1 = 108 \mu\text{V}$ the consecutive counter rolls were the second and third ring. The graph figure 18 shows the temperature distribution at the bottom for these three experiments, when in each case six rings had established. The azimuthal waves appeared again always in the outermost counter roll and with increased horizontal gradient at lower vertical temperature difference.

5. Conclusions

These experiments seem to confirm the evidence obtained earlier, that horizontal circulations can be superposed upon the motions due to a vertical instability, if only the circulations are not too strong and the Rayleigh numbers not much larger than critical. Within these limitations the motions in the experiments described above were as anticipated, namely a superposition of the density and centrifugal circulations upon the convective rings. If there are limits to the superposition rule in the case of non-uniform heating, they did not appear clearly in these experiments, in which horizontal as well as vertical temperature gradients have been much larger than previously (Koschmieder 1966). There is evidently a possibility that motions with a Rayleigh number of $5R_c$ and an average horizontal temperature gradient of $1/5$ of the vertical critical gradient superpose without trouble. On the other hand the possibility to superpose a centrifugal circulation upon the convective rolls seems to be limited. As was found previously with uniform heating (Koschmieder 1967), the motions at $\frac{3}{4}$ r/s do not remain axially symmetric as soon as the first counter roll develops. This has been checked with this apparatus with quasi-uniform heating and was likewise true for non-uniform heating. Although in all three cases there were experimental deficiencies, the appearance of the azimuthal waves in each of these experiments seems to indicate that the transformation from rings to azimuthal oriented motions is inevitable, if the centrifugal circulation becomes too strong. In other words, the superposition of the motions does no longer hold then. That this happens so easily with centrifugal circulations might be due to the strong concentration of the circulation at the rim. Apparently no theoretical study has been made of whether the superposition of a density or centrifugal circulation upon convective rolls is stable against infinitesimal disturbances. An essential part of such a study would be the understanding of the stability of the counter rolls, since the instabilities occur there. One can argue that counter rolls will be unstable, since they impede the horizontal heat transport increasingly. As a matter of fact, a shear layer blocks all horizontal heat transfer and at the same time is ineffective in vertical heat transfer too. Rolls which are aligned parallel to the horizontal temperature gradient will offer better heat conduction. It seems, furthermore, to be necessary

to study the change of the orientation of the rolls experimentally in a more suitable setup, either with a uniform horizontal temperature gradient or with mechanical shear. For the latter case, it is known from the experiments of Avsec (Bénard & Avsec 1938), that a change in the orientation of rolls takes place. The influence of a shear flow on the convective motions in an unstably stratified fluid layer has been studied theoretically by Kuo (1963) and Eisler (1965).

The author would like to thank professor D. Fultz for his interest and the chance to do this work. The support of the work through NSF grants GP-4355 and GA-1023, Atmospheric Sciences Section, National Science Foundation, is gratefully acknowledged.

REFERENCES

- BÉNARD, H. & AVSEC, D. 1938 *J. Phys. Radium*, **9**, 486.
EISLER, T. J. 1965 *Phys. Fluids*, **8**, 1635.
KOSCHMIEDER, E. L. 1966 *Beitr. Phys. Atmos.* **39**, 209.
KOSCHMIEDER, E. L. 1967 *Beitr. Phys. Atmos.* **40**, 216.
KUO, H. L. 1963 *Phys. Fluids*, **6**, 195.
MÜLLER, U. 1966 *Beitr. Phys. Atmos.* **39**, 217.

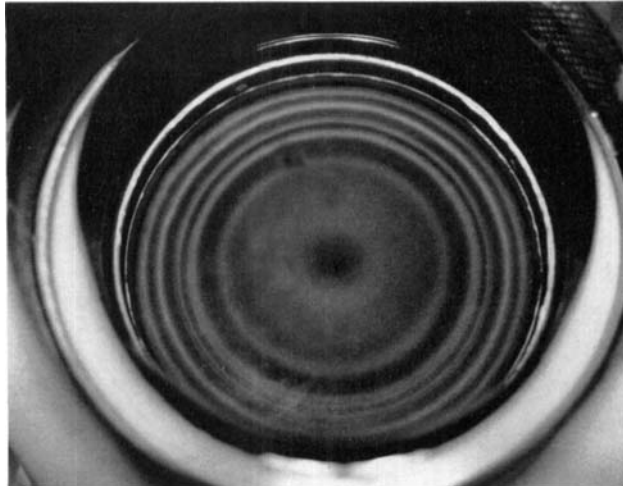

FIGURE 3. Picture of a counter roll and a shear layer.

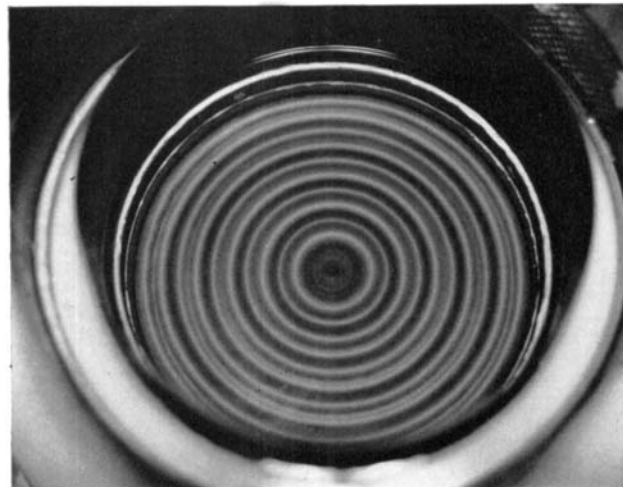

FIGURE 4. Twelve concentric rings.

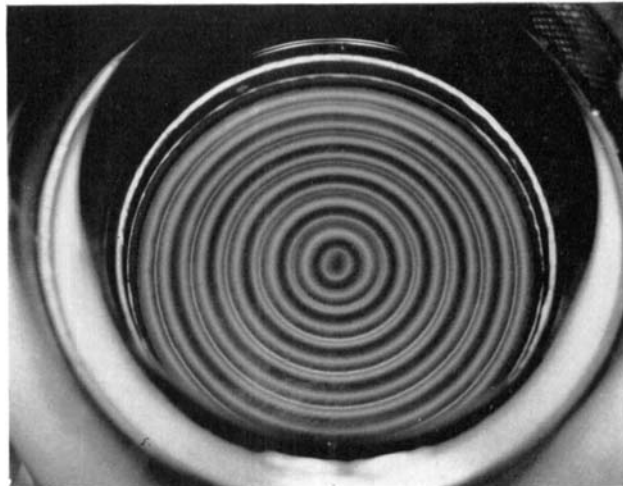

FIGURE 5. Eleven concentric rings.

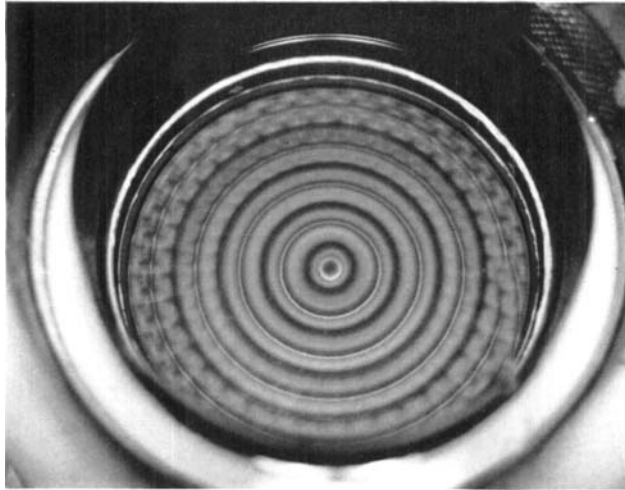

FIGURE 6. Square wave pattern.

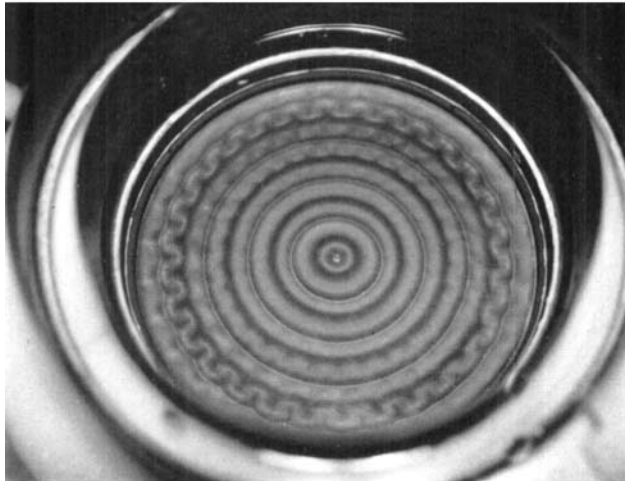

FIGURE 8. Wavy counter roll.

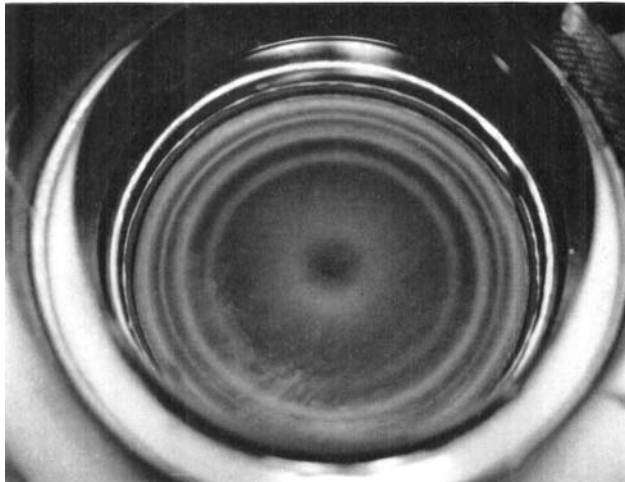

FIGURE 10. First counter roll and second shear layer.

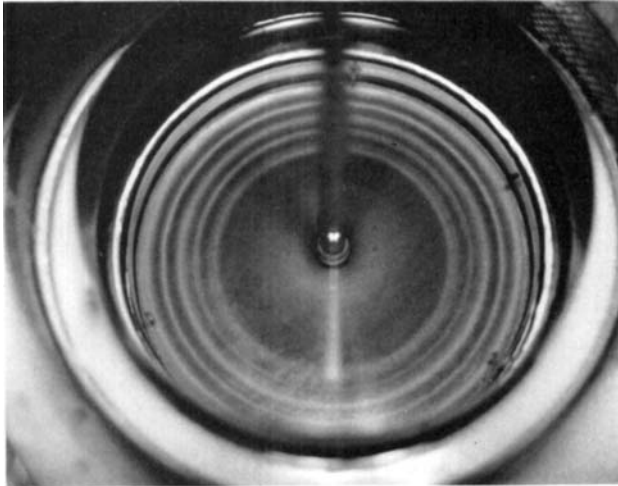

FIGURE 11. See text.

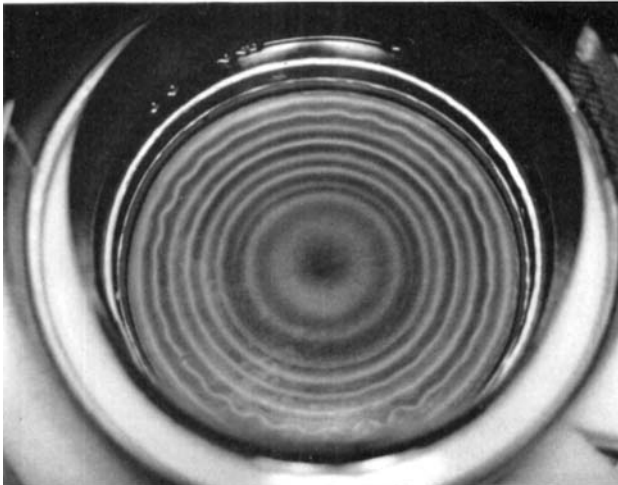

FIGURE 12. Seventh ring appears as counter roll.

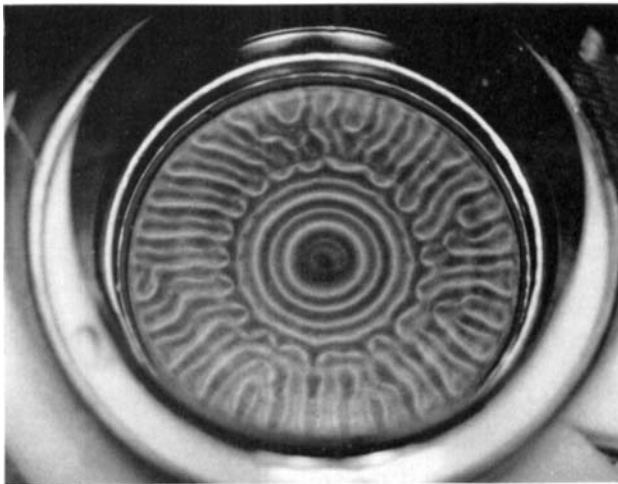

FIGURE 13. Transition to transverse rolls.

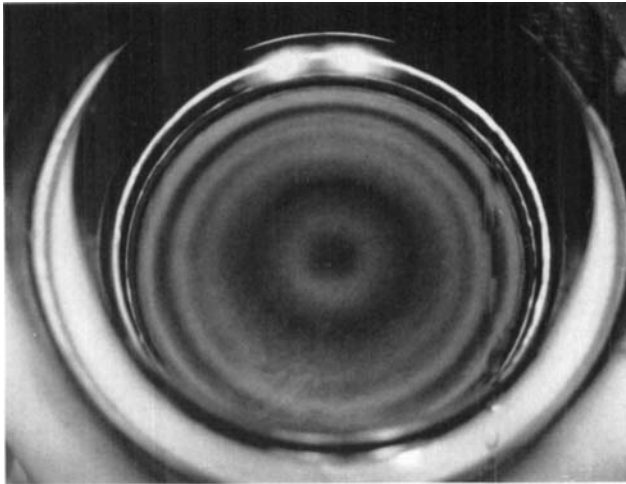

FIGURE 15. First shear layer, rolls and density circulation.

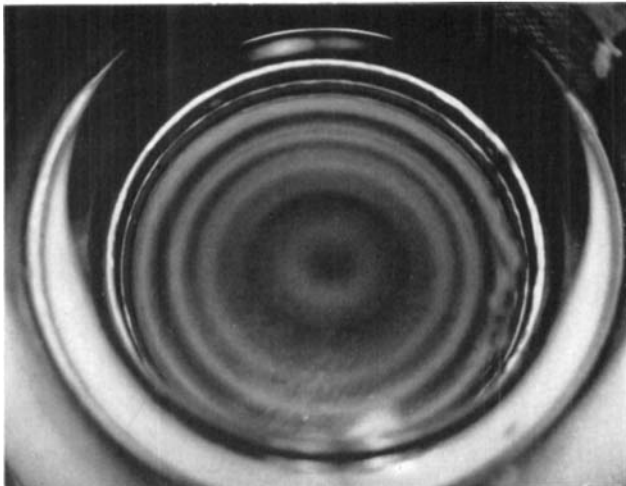

FIGURE 16. Two shear layers, rolls and density circulation.

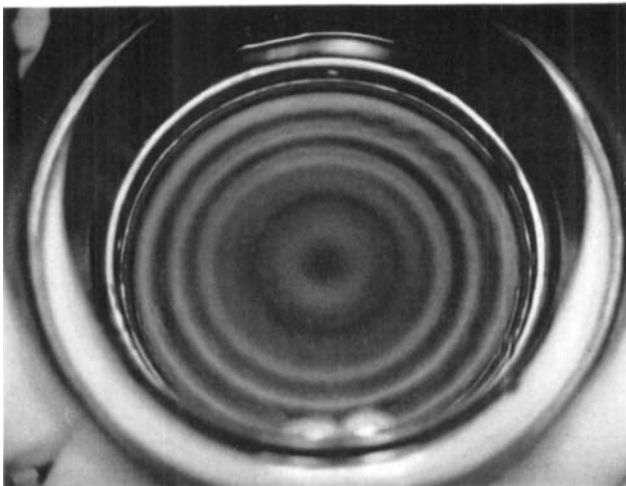

FIGURE 17. First counter roll appears.